

Characterization of residual phase noise in commercial MMIC amplifiers

Nikolay Shtin, Suresh Ojha, Alexander Chenakin

[Summary]

This work reports the development of a simple test setup and the results of residual phase noise measurements performed on a number of commercial MMIC amplifiers from different vendors and based on several semiconductor technologies such as SiGe HBT, InGaP HBT and HEMT. The developed test setup is essentially based on a fixed frequency oscillator, where the amplifier under test forms a part of the oscillation loop, which also includes a low-Q LC resonator and several additional components required to achieve a steady oscillation at the resonator frequency and the desired power level. Thus, according to the performed measurements the lowest residual phase noise at 1.5 GHz frequency has been observed in Mini-Circuits and Qorvo InGaP HBT amplifiers. Meantime, it has been found that pHEMT-based low noise amplifiers and some of the SiGe HBT gain blocks exhibit considerably higher residual phase noise due to its elevated $1/f$ and generation-recombination noise. The obtained amplifier characterization results can be used to select appropriate devices for the future instruments where low phase noise is an important requirement.

1 Introduction

Miniature commercial MMIC amplifiers are the key building blocks for a variety of microwave devices and instruments. Usually, a choice of using a particular amplifier is made by the designer based on the requirements for the amplifier's gain, noise figure, output power and also cost. However, in some application such as microwave frequency synthesizers another important parameter such as residual phase noise comes into play. Unfortunately, often this key amplifier parameter is not provided by the vendor, so it is a common engineering practice to choose amplifiers using "rule of thumb" notions for the selection of low $1/f$ noise devices and trial and error methods. A safer approach consists in a preliminary amplifier residual noise characterization but it has considerable technical difficulties related to the implementation of a test setup with sufficiently low noise floor close to the thermal noise limit and usually requires to employ complex correlation or interferometric measurement techniques [1] to [3].

As an alternative approach to the direct residual phase noise measurement, a relatively simple closed loop test method based on a fixed frequency oscillator can be used. This method assumes implementation of a fixed frequency test oscillator incorporating an LC tank or microstrip line resonator with relatively low Q -factor, so that its phase noise could be directly measured with any appropriate spectrum analyzer or a phase noise measurement system.

Phase noise spectral density of such a simple oscillator can be expressed as:

$$S_{\phi}^{\text{osc}}(f_m) = S_{\phi}^{\text{amp}}(f_m) \left(H(f_m) \right)^2, \quad (1)$$

where f_m is the offset frequency, $H(f_m)$ is the phase noise transfer function of the closed oscillator loop [4], which in case of a single-tank resonator is given by:

$$H(f_m) = 1 + \frac{1}{j f_m 2Q_L / f_0}, \quad (2)$$

where f_0 is the frequency of oscillation and Q_L is the resonator loaded quality factor.

Meanwhile, $S_{\phi}^{\text{amp}}(f_m)$ in eq. (1) is the residual phase noise of the active device, which typically can be approximated as follows:

$$S_{\phi}^{\text{amp}}(f_m) = b_0 + \frac{b_{-1}}{f_m} \quad (3)$$

here b_0 is the additive white noise component independent of the offset frequency and which in case of an amplifier with noise figure NF is given by:

$$b_0 = \frac{kTNF}{P_0}, \quad (4)$$

where k is the Boltzmann constant, T is the ambient temperature, P_0 is the amplifier input power and NF is the amplifier noise figure. The second frequency dependent term in the equation (3) represents $1/f$ or flicker noise component of the amplifier residual phase noise. Thus, com-

binning eqs. (1) and (2) one may find that the amplifier residual phase noise can be expressed as:

$$S_{\varphi}^{amp}(f_m) = S_{osc}(f_m) \left(1 + \frac{f_0^2}{(f_m 2Q_L)^2} \right)^{-1}, \quad (5)$$

According to eq. (5) the amplifier noise can be found once both the oscillator phase noise PSD and the resonator loaded quality factor are measured. In the next section of this paper, the details on the test setup implementation along with the characterization results for a number of commercial MMIC amplifiers are presented.

2 Test setup

Block diagram of the developed residual phase noise test setup is shown in Figure 1. Essentially, the setup is a fixed frequency loop oscillator, which contains amplifier under test as well as several auxiliary components including a variable attenuator and a delay line used to adjust the gain and phase of the loop needed to achieve steady oscillation at the resonator frequency. A 10-dB directional coupler connected at the amplifier output has been used to sample a fraction of the oscillator signal into external load.

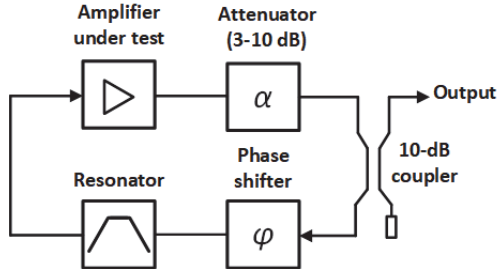

Figure 1 Block diagram of the residual phase noise test setup.

A physical implementation of the setup is shown in Figure 2. Since most of the measurements were taken at the frequency of interest of 1.5 GHz, a series LC tank was used as a resonator circuit. The resonator’s loaded quality factor was set to $Q_L/2$ using small value capacitors at the input and output of the LC tank. The loaded quality factor of 29.5 has been measured. In this particular case, such a low quality factor can be considered as an advantage since the resulting oscillator phase noise level is quite high and can be easily measured. Another resonator circuit has been built using a microstrip open-stubs resonator similar to the one reported by Hosoya et al [5]. In our implementation the resonator was tuned to 5.1 GHz and has had a two-port transmission configuration required for the loop oscillator.

The mentioned resonator has been chosen due to its simple implementation and because it allows the control of the Q_L and thus the insertion loss in a very efficient way by simply changing the length of one of the stubs. Thus, the stub lengths were adjusted to have Q_L of about 50 and the insertion loss of 10 dB.

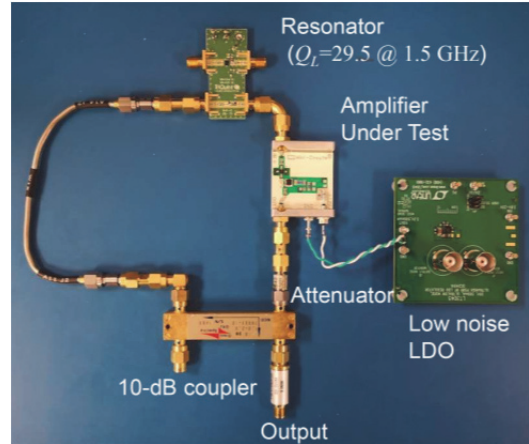

Figure 2 Implimentation of the residual phase noise closed-loop test setup at 1.5 GHz.

3 Measurement results

The results of the residual phase noise measurements taken for a number of InGaP and SiGe HBT as well as GaAs pHEMT and GaN HEMT MMIC amplifiers from different vendors including Analog Devices, Mini-Circuits, RFMD and Qorvo are shown in Figures 3 to 7. In order to obtain these data, first, the closed-loop phase noise measurements were performed using Keysight E5052B signal source analyzer. Subsequently, the amplifier residual noise was derived using eq. 5. Most of the measurements were per-

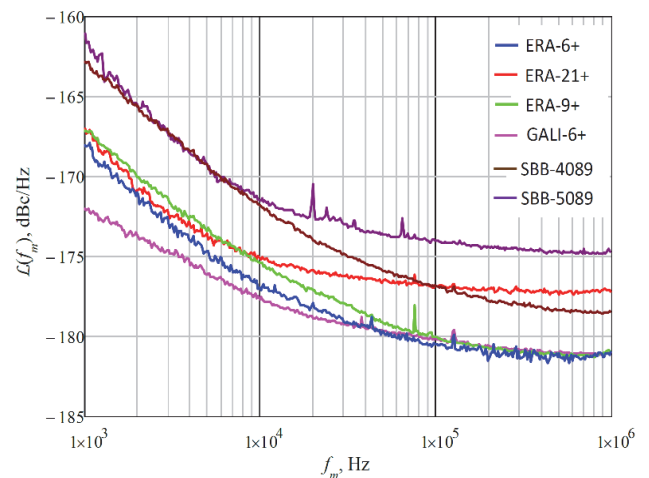

Figure 3 Measured residual phase noise of Mini-Circuits and RFMD InGaP HBT amplifiers at 1.5 GHz.

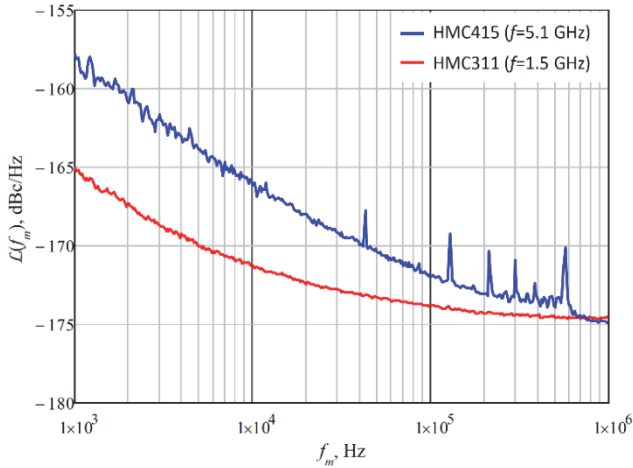

Figure 4 Measured residual phase noise of Analog Devices InGaP HBT amplifiers at 1.5 GHz and 5.1 GHz.

formed at the power levels corresponding to the amplifier gain compression of 2 to 3 dB. The lowest residual phase noise $\mathcal{L}(10\text{kHz})=-172\dots-177$ dBc/Hz has been observed in the Mini-Circuits and Qorvo HBT amplifiers. Meantime, it has been found that pHEMT-based low-noise amplifiers and some of the SiGe HBT gain blocks exhibit considerably higher residual phase noise due to its elevated $1/f$ and generation-recombination (G-R) noise [6 to 8]. It is worth mentioning that quite high G-R noise has been observed in the Analog Devices HMC476 amplifier (Figure 5) that is not something typical for SiGe HBT based devices.

Thus, measured residual phase noise of all the characterized HBT amplifiers as well as their white and flicker noise coefficients b_0 and b_{-1} are given in Table 1. The lowest b_{-1} as well as b_0 were obtained for Mini-Circuits GALI-6,

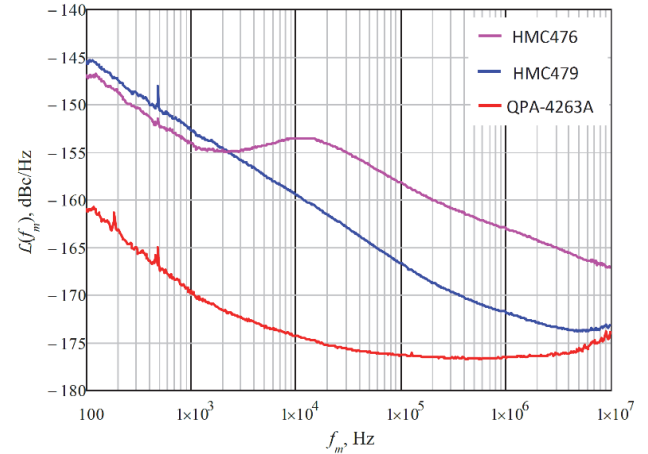

Figure 5 Measured residual phase noise of SiGe HBT amplifiers at 1.5 GHz.

ERA-6 and Qorvo QPA-4263A HBT amplifiers. Interestingly, it has been found that increasing gain compression, i. e. operating MMIC HBT amplifier in more non-linear regime may reduce the residual phase noise by several dB as it can be seen in Figure 7. Such a behavior, in general, seems to be in agreement with the results presented for HBT based amplifiers in [2] and [3], where it was found that white noise tends to reduce when the input power is increased although at certain power levels there's slight noise degradation due to increase of the amplifier noise figure. Meantime, the $1/f$ noise dependence from the amplifier output power was observed to be more complex. Thus, in case of QPA-4263A SiGe HBT amplifier, the highest $1/f$ noise levels were observed when the amplifier was operated at 1 dB and 3 dB gain compression. Along with that, no considerable

Table 1 Residual phase noise and main parameters of the characterized commercial HBT MMIC amplifiers.

Amplifier under test	Technology	Test frequency, GHz	Gain, dB	NF, dB	P1dB, dBm	$\mathcal{L}(10\text{ kHz})$, dBc/Hz	b_0 , dBc/Hz	b_{-1} , dBc/Hz
Analog devices								
HMC476	SiGe HBT	1.5	18.0	2.5	12.0	-153.7	—	-127.2
HMC479	SiGe HBT	1.5	14.0	4.1	17.0	-159.5	-174.0	-124.9
HMC311	InGaP HBT	1.5	15.0	4.7	15.5	-171.4	-174.7	-135.4
HMC415	InGaP HBT	5.1	20.0	6.0	22.0	-166.1	-175.2	-128.0
Mini-Circuits								
ERA-6+	InGaP HBT	1.5	12.0	4.5	17.2	-177.0	-181.4	-138.5
ERA-9+	InGaP HBT	1.5	8.4	5.3	14.1	-175.4	-181.3	-137.2
ERA-21+	InGaP HBT	1.5	13.5	4.3	12.6	-175.2	-177.2	-138.2
GALI-6+	InGaP HBT	1.5	12.0	4.5	18.2	-177.7	-181.1	-142.2
Qorvo								
QPA-4263A	SiGe HBT	1.5	12.6	4.4	15.8	-174.4	-176.8	-140.5
RFMD								
SBB-4089	InGaP HBT	1.5	15.0	4.4	19.0	-171.8	-178.7	-133.0
SBB-5089	InGaP HBT	1.5	20.5	3.9	20.4	-171.5	-175.0	-132.9

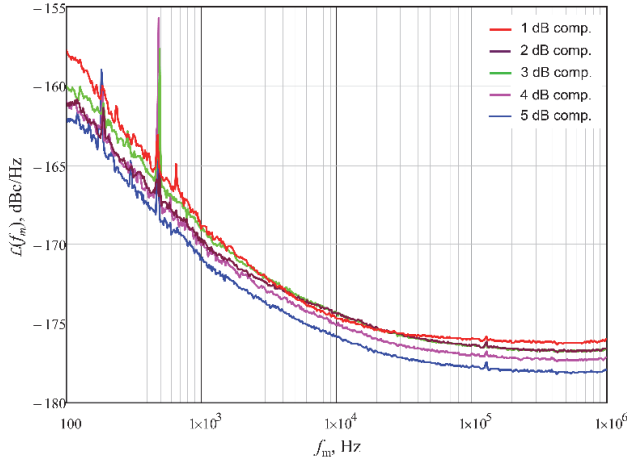

Figure 6 Measured residual phase noise of Qorvo SiGe HBT amplifier QPA-4263A at different gain compression levels.

degradation of the white noise has been observed at 3 dB gain compression point. The lowest levels of both $1/f$ and white noise were achieved at the maximum tested gain compression of 5 dB.

The characterized pHEMT/HEMT amplifiers were found to exhibit quite pronounced G-R noise. In the presence of G-R noise processes, the overall frequency dependent noise can be treated as a superposition of the $1/f$ noise and of the several Lorentzian components used to describe the G-R noise contribution [8]:

$$S_{\varphi}^{amp}(f_m) = \frac{b_{-1}}{f_m} + \sum_{i=1}^n \frac{C_i / f_{0i}}{1 + (f_m / f_{0i})^2} \quad (6)$$

where C_i/f_{0i} is the zero frequency plateau value, and f_{0i} is the corner frequency of the i th G-R noise process.

Residual phase noise spectra measured for Analog Devices HMC8411, Mini-Circuits PMA3-83LN GaAs pHEMT amplifiers as well as for Qorvo TGA-2237 GaN HEMT power amplifier are shown in Figure 7. Meanwhile, the $1/f$ noise and G-R noise parameters b_{-1} , C_i/f_{0i} and f_{0i} fitted using expression (6) are given in Table 2. It is to mention that minimum of three G-R noise process were required to fit the measured spectra of the HMC8411 and TGA-2237, while four process were necessary for the PMA3-83LN noise

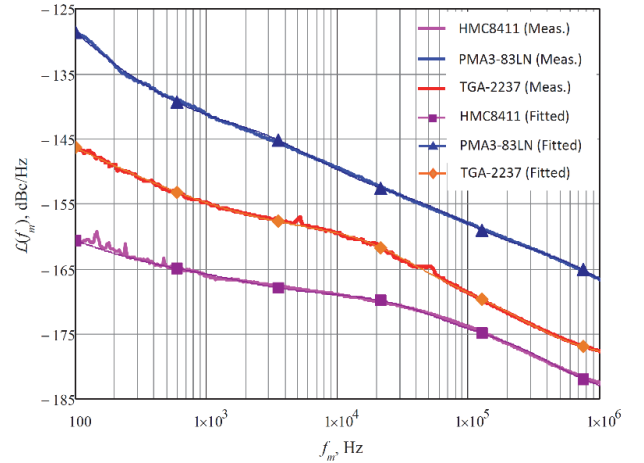

Figure 7 Measured residual phase noise of GaAs pHEMT and GaN HEMT amplifiers at 1.5 GHz.

spectrum. As one may see, in case of the pHEMT/HEMT amplifiers, the G-R noise dominates over the $1/f$ noise in the frequency range from 1 kHz to several hundred kHz, so the major G-R noise processes have corner frequencies in the 1 to 4 kHz and 20 to 60 kHz ranges. As stated in [8], these noise processes mainly originate from deep-level traps in the GaAlAs layer often also called DX centers. It is important to note that weaker G-R noise processes with corner frequencies well above 100 kHz were also observed in all the devices. Moreover, in case of the PMA3-83LN amplifier, a major noise process with very low corner frequency of 10 Hz has been identified. It is known that noise processes with such a low corner frequency may originate due to trapping and detrapping on EL2 deep donor level of the HEMT buffer layer when the device is operated near pinch-off i. e. $V_{GS} \approx 0$ [8]. From three tested HEMT amplifiers the HMC8411 proved to have the lowest residual phase noise $\mathcal{L}(10\text{kHz}) = -169$ dBc/Hz, which is several dB higher compared to the tested HBT amplifiers due to its G-R noise. Although, it is worthwhile to note that HMC8411 $1/f$ noise is similar to the one observed in the best HBT amplifiers.

Table 2 Residual phase noise and main parameters of the characterized pHEMT/HEMT MMIC amplifiers.

Amplifier under test	Gain dB	NF dB	P1dB dBm	b_{-1} dBc/Hz	C_1/f_{01} dBc/Hz	f_{01} kHz	C_2/f_{02} dBc/Hz	f_{02} kHz	C_3/f_{03} dBc/Hz	f_{03} kHz	C_4/f_{04} dBc/Hz	f_{04} kHz
GaAs PHEMT												
HMC8411	15.5	1.6	12.0	-141.9	-170.0	1.7	-170.2	36.0	-175.8	265	—	—
PMA3-83LN	21.0	1.5	18.0	-115.3	-109.8	0.01	-144.8	3.7	-155.2	55.0	-163.0	700
GaN HEMT												
TGA-2237	20.0	—	33.0	-126.5	-160.0	20.0	-170.9	170	-183.7	2500	—	—

4 Conclusions

A residual phase noise test setup based on closed loop approach using fixed frequency oscillators at 1.5 and 5.1 GHz has been developed. The setup has been used to measure residual phase noise in a number of commercial MMIC amplifiers based on different technologies such as InGaP HBT, SiGe HBT, GaAs pHEMT and GaN HEMT. It has been found that Mini-Circuits InGaP and Qorvo SiGe HBT amplifiers exhibit the lowest residual phase noise, while characterized HEMT and pHEMT based amplifiers proved to have more elevated residual noise impacted by $1/f$ and generation-recombination noise. The obtained results can be used to select appropriate amplifiers for test instruments where low phase noise is an important requirement.

References

- 1) E. Rubiola, *Phase Noise Metrology*, Springer-Verlag. Berlin Heidelberg, 2000, pp. 189-215.
- 2) R. Boudot, and E. Rubiola, "Phase noise in RF and microwave amplifiers," *IEEE Trans. Ultras. Ferroelec. Freq. Contr.*, vol. 59, no. 12, pp. 2613-2624, 2012.
- 3) G. Cibiel, L. Escotte, O. Llopis, and M. Chaubet, "High-frequency noise contribution to phase noise in microwave oscillators and amplifiers," in *Proc. SPIE 5844, Noise in Devices and Circuits II*, vol. 5470, pp. 390-401, 2004.
- 4) E. Rubiola, *Phase Noise and Frequency Stability in Oscillators*, Cambridge University Press, 2009.
- 5) K. Hosoya, S. Tanaka, Y. Amamiya, T. Niwa, H. Shimawaki, and K. Honjo, "RF HBT oscillators with low-phase noise and high-power performance utilizing a $(\lambda/4 \pm \delta)$ open-stubs resonator", *IEEE Trans. Circuit and Systems-I*, vol. 53, no. 8, pp. 1670-1682, August 2006.
- 6) J.-C. Nallatamby, S. Laurent, M. Prigent, J.-C. Jacquet, D. Floriot, and S. Delage, "Comprehensive analysis of GR noise in InGaP-GaAs HBT by physics-based simulation and low frequency characterization," *J. Comput. Electron.*, vol. 14, no. 1, pp. 4-14, Mar. 2015.
- 7) J. Ch. Nallatamby, M. Prigent, M. Camiade, A. Sion, C. Gourdon, and J. J. Obregon, "An Advanced Low-Frequency Noise Model of GaInP-GaAs HBT for Accurate Prediction of Phase Noise in Oscillators," *IEEE Trans. Microwave Theory Tech.*, vol. 53, no. 5, pp. 1601-1612, May. 2005.
- 8) R. Plana, L. Escotte, O. Llopis, H. Amine, T. Parra, M. Gayral, J. Graffeuil, "Noise in AlGaAs/InGaAs/GaAs Pseudomorphic HEMTs from 10 Hz to 18 GHz", *IEEE Trans. on Electron Devices*, May 1993.

Author



Alexander Chenakin
Service Infrastructure Solutions
US Division
Measurement Business Division



Suresh Ojha
Service Infrastructure Solutions
US Division
Measurement Business Division



Nikolay Shtin
Service Infrastructure Solutions
US Division
Measurement Business Division

Publicly available