

Residual noise characterization using interferometric measurement technique

Nikolay Shtin, Suresh Ojha, Alexander Chenakin

[Summary]

Interferometric residual noise measurement technique provides ultra-high sensitivity and achieves very low measurement system noise floor. This technique utilizes a microwave interferometer to cancel the carrier signal, thus enhancing the visibility of the DUT residual noise. However, traditional implementations of this measurement technique is quite complex, so it is very rarely used in practical measurements and mostly has been only reported in the research literature. In this paper we present a simple residual noise measurement system that utilizes the interferometric method along with a commercial phase noise analyzer. It has been revealed that this approach does not require an involved calibration and provides a good accuracy and excellent sensitivity at the offset frequencies above 1 kHz. The proposed approach has been employed to measure residual amplitude and phase noise in a number of microwave components including MMIC amplifiers, SAW resonators, frequency multipliers and dividers in the 1.5 to 6.4 GHz range.

1 Introduction

Low phase noise has become an important requirement for the modern test and measurement instruments. In order to achieve the required phase noise performance, it is essential to be able to identify RF and microwave components exhibiting the lowest residual phase and amplitude noise. Thus, accurate residual noise characterization is an important and at the same time very challenging problem. Frequently, residual noise measurements lack accuracy or are impacted by the measurement system sensitivity or the system noise floor. The last one depends on the employed measurement approach and the available signal source.

The highest sensitivity is achieved using so-called interferometric technique, which allows to perform real-time noise measurements with sensitivity better than -190 dBc/Hz at the offset frequencies greater than 1 kHz¹⁾. Block diagram of the traditional residual noise measurement system based on interferometric approach is shown in Figure 1.

The key element of the system is the Sann bridge²⁾, which is also sometimes referred as a microwave interferometer^{1), 3)}. The microwave interferometer consists of two branches. The first branch contains the device under test (DUT) and the variable attenuator, while the second branch consists of the variable phase shifter (VPS) and AM/FM modulator, which is utilized for the system calibration purpose. The two interferometer branches are connected to the inputs of the hybrid coupler used to produce the signal interference. Thus, when the hybrid input signals are equal in amplitude and have appropriate phases, all the power goes to the Σ output of the hybrid coupler, while the carrier is suppressed at the Δ output. The amount of carrier suppression defines the amplification of the DUT noise. The signal with suppressed carrier is amplified by the low-noise amplifier (LNA) and compared to the signal at the Σ output using phase detector (PD). The LNA and PD are the key components of the readout system¹⁾. For the proper operation, the readout system also requires

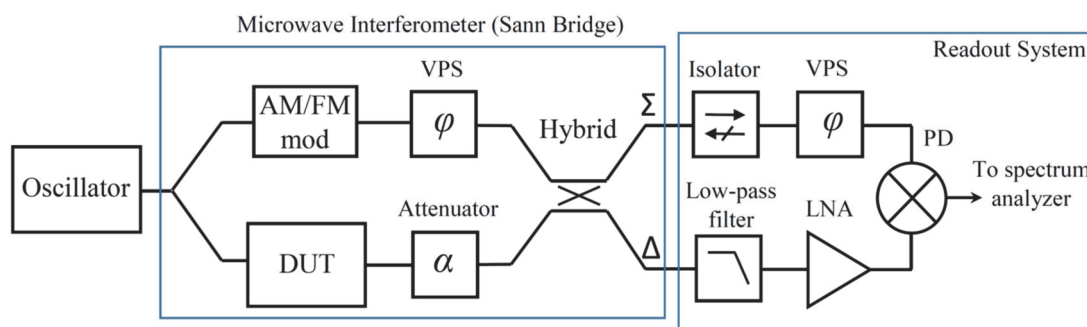

Figure 1 Traditional interferometric noise measurement system.

several additional components such as low-pass filter (LPF), microwave isolator and VPS. The LPF is mostly required only for active DUTs and is used to suppress the harmonics. The isolator is required to reduce the reflection from the PD input as well as to improve the isolation between the PD inputs, while the VPS is used to provide appropriate phases for the signals at the PD inputs.

It is worth noting that despite its ultra-high sensitivity the traditional interferometric noise measurement system is quite complex and requires an involved calibration. Thus, in order to perform the calibration of this type of system, a calibrated broadband noise source⁴⁾ or a low index AM/FM modulator⁵⁾ are required. In order to reduce the measurement system complexity and simplify its calibration, the traditional PD-based readout system can be replaced by a commercial phase noise analyzer (PNA). The advantages and drawbacks of this solution as well as noise measurement results obtained for a number of microwave and RF components are discussed in this paper.

2 Theoretical background

The block diagram of the proposed PNA-based interferometric measurement system is shown in Figure 2. Using a PNA instead of the PD-based readout system allows to reduce the system complexity and simplify its calibration. The calibration of the proposed PNA-based system essentially consists of finding the correction factor that needs to be applied to the PNA measurement in order to obtain the DUT noise spectral density. It can be shown that for this system both the DUT residual amplitude and phase noise can be expressed as follows:

$$\mathcal{L}_{DUT}(f) = 2\mathcal{L}_{PNA}(f)/CS, \quad [1]$$

where CS is the amount of carrier suppression given by:

$$CS = \frac{1}{2} P_{\Sigma} / P_{\Delta}, \quad [2]$$

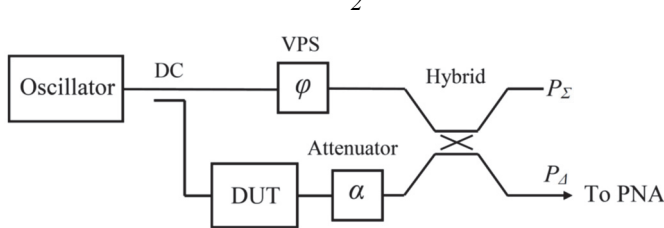

Figure 2 PNA-based noise measurement system using interferometric method.

here P_{Σ} and P_{Δ} are respectively the signal power levels at the Σ and Δ outputs of the hybrid coupler. Thus, the PNA correction factor is essentially equal to $(\frac{1}{2} P_{\Sigma} / P_{\Delta})^{-1}$. Both P_{Σ} and P_{Δ} can be easily measured in real time using the same PNA and/or an auxiliary spectrum analyzer or a power meter.

The noise floor of the proposed system in case of the phase and amplitude measurements is given by:

$$\mathcal{L}_{\phi}^{NF}(f) = \frac{k_B T_0}{P_{in} L_{hyb}} + \frac{2\mathcal{L}_{\phi}^{NF/PNA}(f)}{CS} + \frac{2\mathcal{L}_{\phi}^{OSC}(f)}{CS} \quad [3]$$

$$\mathcal{L}_{AM}^{NF}(f) = \frac{k_B T_0}{P_{in} L_{hyb}} + \frac{2\mathcal{L}_{AM}^{NF/PNA}(f)}{CS} + \frac{2\mathcal{L}_{AM}^{OSC}(f)}{CS}, \quad [4]$$

where k_B is the Boltzmann constant, T_0 is the ambient temperature, P_{in} is the power at the hybrid coupler input, L_{hyb} is the power loss in the hybrid coupler. Meantime, $\mathcal{L}_{\phi}^{NF/PNA}(f)$, $\mathcal{L}_{AM}^{NF/PNA}(f)$, $\mathcal{L}_{\phi}^{OSC}(f)$ and $\mathcal{L}_{AM}^{OSC}(f)$ are respectively the PNA amplitude and phase noise floor and the amplitude and phase noise of the pump oscillator. It is to note that the contributions of the PNA noise floor as well as of the pump oscillator noise are both reduced by the amount of carrier suppression (typically 40-50 dB), so that noise measurements well below the PNA noise floor can be performed. This can be considered as one of the main advantages of the interferometric noise measurement system.

The sensitivity of the proposed system can be improved if two identical DUTs are used in both interferometer branches as it is shown in Figure 3. The noise floor of such a dual DUT system is given by:

$$\mathcal{L}_{\phi}^{NF}(f) = \frac{k_B T_0}{2P_{in} L_{hyb}} + \frac{\mathcal{L}_{\phi}^{NF/PNA}(f)}{CS} + \frac{\mathcal{L}_{\phi}^{OSC}(f)}{CS} \quad [5]$$

$$\mathcal{L}_{AM}^{NF}(f) = \frac{k_B T_0}{2P_{in} L_{hyb}} + \frac{\mathcal{L}_{AM}^{NF/PNA}(f)}{CS} + \frac{\mathcal{L}_{AM}^{OSC}(f)}{CS}, \quad [6]$$

Essentially, the dual DUT system has 3 dB lower thermal noise component. Meantime, the PNA correction factor for this system equals $(\frac{1}{2} P_{\Sigma} / P_{\Delta})^{-1}$.

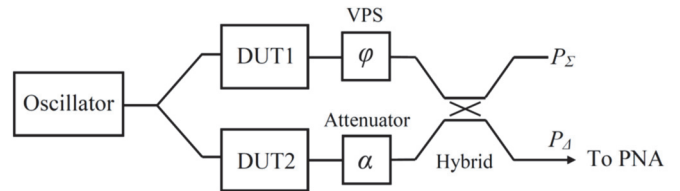

Figure 3 Dual DUT PNA-based noise measurement system using interferometric method.

3 Residual noise measurement results

In this section the results of residual noise measurements for a number of microwave and RF components including MMIC amplifiers, SAW resonator, low noise frequency multiplier and low noise regenerative divider are presented. The MMIC amplifier noise measurements were performed using the system shown in Figure 2 along with R&S FSWP phase noise analyzer. The MMIC amplifiers were evaluated at power levels close to P1dB. Meantime, the dual DUT measurement system shown in Figure 3 was employed for the rest of the characterized components. A low noise pump oscillator based on 100 MHz OCXO and low noise frequency multiplier providing 1.6 and 6.4 GHz frequencies has been used in both measurement systems.

The results of the residual noise measurements taken for InGaP/GaAs HBT amplifiers HMC606 (Analog Devices) and CMD275 (Qorvo) as well as for low noise GaAs pHEMT amplifier HMC8410 are shown in Figures 4-6. As one may observe the HBT amplifiers have close-in phase noise as low as -165 dBc/Hz at 10 kHz offset frequency. Meantime, the residual phase noise of the HMC8410 GaAs pHEMT amplifier proved to be about -155 dBc/Hz at the same 10 kHz offset frequency. It is interesting to note that despite their excellent close-in phase noise, the HBT amplifiers may exhibit elevated broadband amplitude noise as well as elevated phase noise at the offset frequencies above 10 MHz (e. g. see Figure 5).

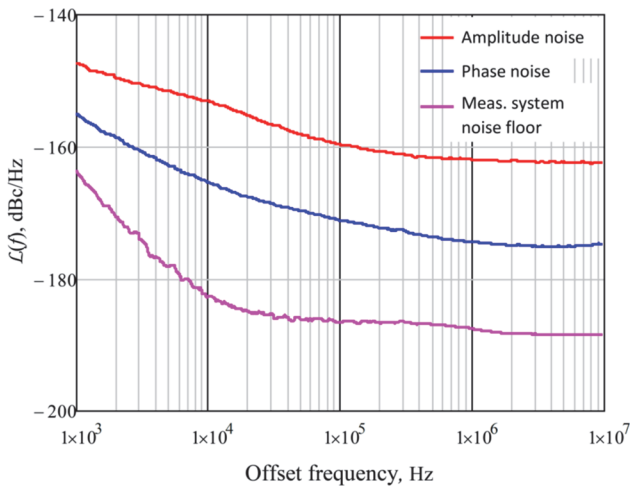

Figure 4 Measured residual noise of Analog Devices HMC606 MMIC amplifier ($f = 6.4$ GHz).

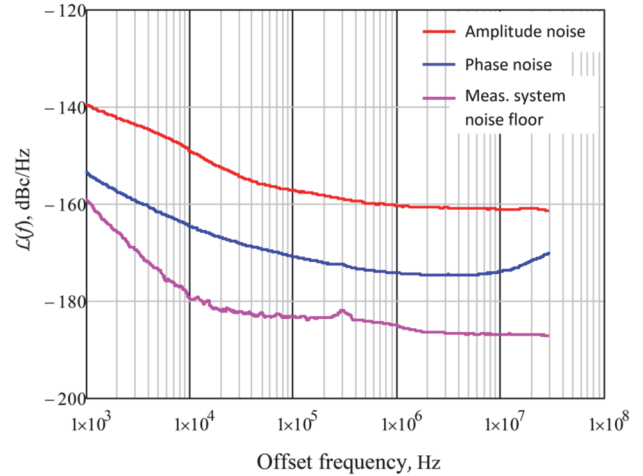

Figure 5 Measured residual noise of Qorvo CMD275 MMIC amplifier ($f = 6.4$ GHz).

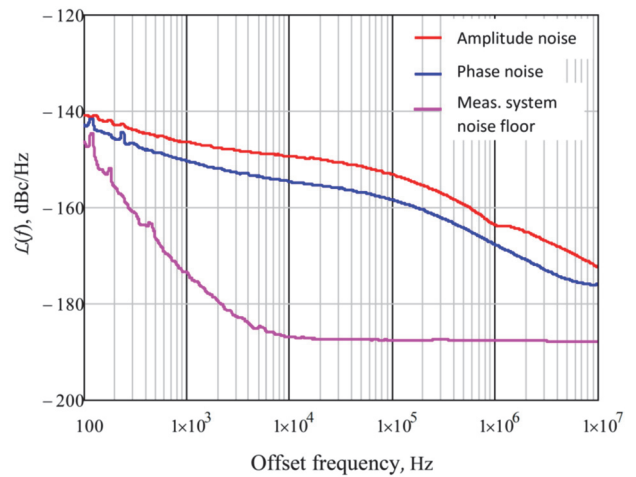

Figure 6 Measured residual noise of Analog Devices HMC8410 MMIC amplifier ($f = 6.4$ GHz).

The characterized SAW resonator is TAI-SAW Technology TC0663A with resonant frequency of 1.57 GHz and unloaded Q-factor of 5,000. The resonator was measured in the series configuration. Its input and output coupling coefficients were set to $\beta_1 = \beta_2 = 0.5$ using small value shunt capacitors at the resonator input and output. The measured residual phase noise at different resonator drive levels is shown in Figure 7. Thus, at $P_m = 0$ dBm the resonator residual phase noise proved to be better than -163 dBc/Hz @ 10 kHz offset. It is worth noting that this result is within several dB compared to the measurements reported by Vaillant et. al. for a 2.44 GHz SAW resonator⁶.

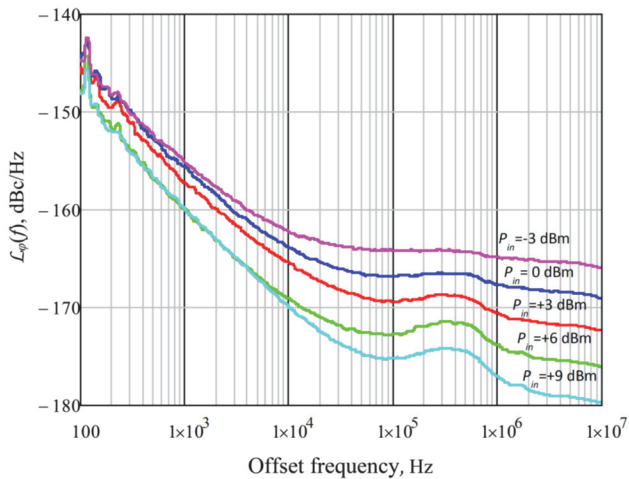

Figure 7 Measured residual phase noise of 1.57 GHz SAW resonator.

The developed dual DUT interferometric system also has been used to characterize the devices that have different input and output frequencies. Thus, Figure 8 shows residual amplitude and phase noise of the low noise times four frequency multiplier with 6.4 GHz output frequency. The multiplier is based on two low noise Schottky diode frequency doublers (KSX2-442+ and KSX2-14+) and contains a low noise output power amplifier (PA) providing about +19 dBm of power.

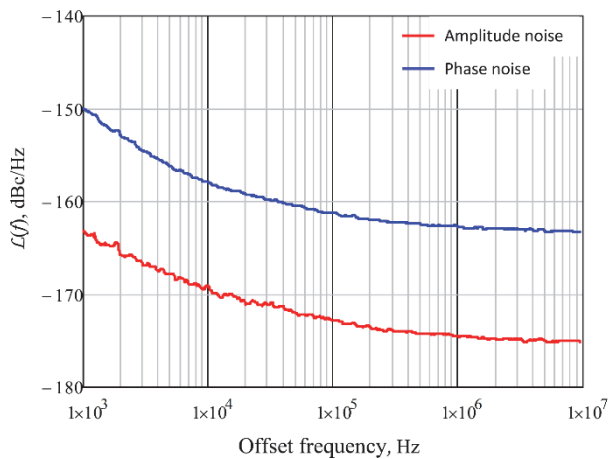

Figure 8 Measured residual amplitude and phase noise of times four frequency multiplier.

Ultimately, residual phase noise measurement results obtained for the 6.4 GHz low noise regenerative divider (LNRD) are presented in Figure 9. The divider was implemented using configuration similar to that one reported by Mossammaparast et. al.⁷⁾. The developed LNRD utilizes Mini-Circuit SIM-153MH+ mixer and GALI-51F+ MMIC amplifier. The LNRD residual phase noise proved to be about -164 dBc/Hz at 10 kHz offset frequency.

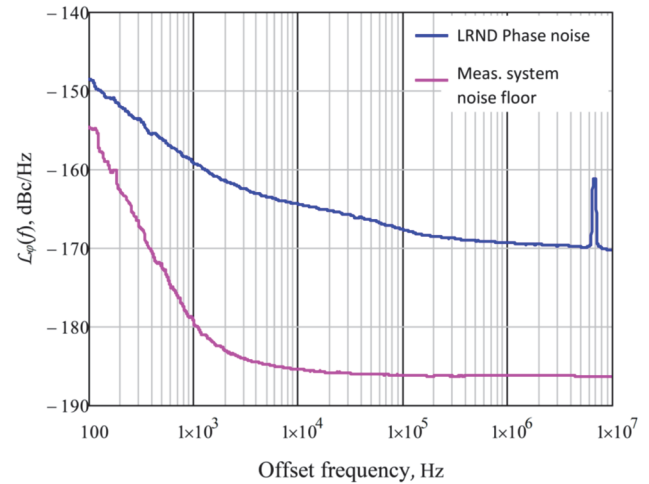

Figure 9 Measured residual phase noise of 6.4 GHz LNRD.

4 Conclusions

A phase noise measurement system based on interferometric method has been presented. A commercial phase noise analyzer (PNA) has been employed instead of the traditionally used phase detector based readout system. It has been shown that such a noise measurement system possess ultra-high sensitivity and allows to perform residual noise measurements well below the PNA noise floor.

References

- 1) E. N. Ivanov, M. E. Tobar and R. A. Woode, "Microwave interferometry: application to precision measurements and noise reduction techniques," in *IEEE Transactions on Ultrasonics, Ferroelectrics, and Frequency Control*, vol. 45, no. 6, pp. 1526-1536, Nov. 1998.
- 2) K. H. Sann, "The Measurement of Near-Carrier Noise in Microwave Amplifiers," in *IEEE Transactions on Microwave Theory and Techniques*, vol. 16, no. 9, pp. 761-766, September 1968.
- 3) Rubiola E., Giordano V. "Phase Noise Metrology," in *Noise, Oscillators and Algebraic Randomness, Lecture Notes in Physics*, vol. 550. Springer, Berlin, Heidelberg.
- 4) F. L. Walls, "Suppressed carrier based PM and AM noise measurement techniques," *Proceedings of International Frequency Control Symposium*, 1997, pp. 485-492.
- 5) F. L. Walls, "Secondary standard for PM and AM noise at 5, 10, and 100 MHz," in *IEEE Transactions on Instrumentation and Measurement*, vol. 42, no. 2, pp. 136-143, April 1993.
- 6) E. Vaillant, F. Sthal, J. Imbaud, V. Soumann, F-X. Esnault and G. Cibiel, "2.44-GHz Surface Acoustic Wave Resonator Phase

Noise Measured by Carrier Suppression Technique," in IEEE Transactions on Ultrasonics, Ferroelectrics, and Frequency Control, vol. 66, no. 1, pp. 247-250, Jan. 2019.

- 7) M. Mossammaparast, C. McNeilage, P. Stockwell and J. H. Searls, "Phase noise of X-band regenerative frequency dividers," Proceedings of the 2000 IEEE/EIA International Frequency Control Symposium and Exhibition, 2000, pp. 531-535.

Author



Alexander Chenakin
Service Infrastructure Solutions
US Division
Measurement Business Division



Suresh Ojha
Service Infrastructure Solutions
US Division
Measurement Business Division



Nikolay Shtin
Service Infrastructure Solutions
US Division
Measurement Business Division

Publicly available